

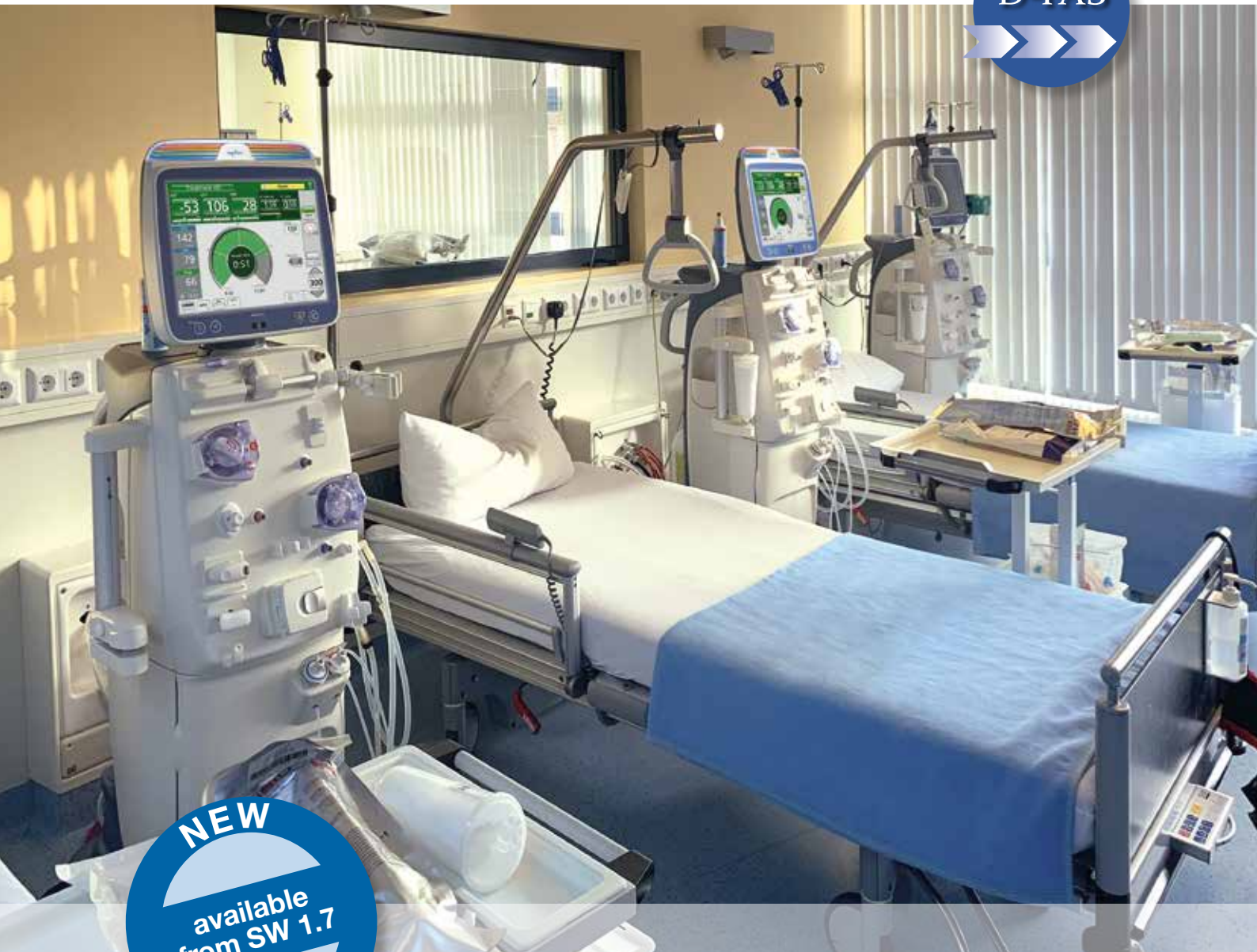

Hemodialysis Equipment **DBB-EXA**

D-FAS



NEW

available
from SW 1.7

features

CE
0123

Innovations for Human Care.

Concept

User-friendly and cost efficient dialysis monitor providing safe and adequate hemodialysis.

DBB-EXA has been developed for the value-oriented dialysis providers who are committed to high quality and safety standards and are looking for a monitor **to deliver standard HD treatments along with advanced therapies.**

DBB-EXA is a compact, user-friendly and cost efficient dialysis monitor providing a safe and efficient hemodialysis.

With a variety of configurations and options, **DBB-EXA meets the needs of the modern dialysis facility.**

- / For the administrator** who manages the dialysis facility, and is seeking a way to reduce the treatment costs, DBB-EXA is the dialysis machine that can **reduce the total costs of ownership.**
- / For the healthcare professional** who requires more time for the patient, DBB-EXA is the dialysis machine that can provide **more time for patient care** by reducing routine dialysis tasks.
- / For the dialysis patient,** DBB-EXA is the dialysis machine that provides a more **comfortable treatment environment** thanks to its smart, quiet and compact design.
- / For the nephrologist** who wants to deliver a safe and effective treatment, DBB-EXA is the dialysis machine that provides **accurate and safe monitoring** as well as flexible treatment modes.

Ecological

Environment awareness is a part of NIKKISO's corporate philosophy. New products and technology developments aim to reduce the environmental impact and **to preserve resources.**

/ Resource-saving appliance management



- **Drain of bloodline sets:** The reduced weight of the contaminated waste that needs to be disposed of has a **positive impact** on logistics and environment.
- Optimized energy use via **integrated heat exchangers** between in- and outflow.
- Screen **motion sensor** enabling automatic switch-off/on of screen.

/ Dialysate Flow Adaption

When the dialysate flow rate equals the blood flow rate, almost 90% of the small molecules clearance is achieved. By setting a factor (e.g. 1,5), the dialysate flow rate increases automatically with an increasing blood flow rate (BFR) thereby ensuring an equal treatment efficiency for all conditions. This may help to optimize **dialysis fluid consumption and costs in terms of energy, water etc.** without compromising Kt/V.



Dialysate flow adaption - Factor programming

Reducing costs

Reduced consumables, waste weight reduction and minimized maintenance costs lower the treatment costs with DBB-EXA.

Reduced consumables

- Priming, wash back and emergency bolus can be performed with dialysis fluid **to save on saline costs**.
- Online priming, wash back and emergency bolus can be performed **without substitution line or special adapter**, therefore eliminating extra costs.
- Online priming solution and substitution fluid is purified using the integrated **reusable** double filtration (cascade) with two EF-02 D endotoxin retentive filters (ETRF).
- Priming fluid from the extracorporeal circuit can be drained through the drain port **to eliminate the need for a drain bag**. The drain port can be utilized in priming for both dialysis fluid and saline.
- BVM can be measured with NIKKISO standard bloodline set. **No need for extra consumables for BVM.**

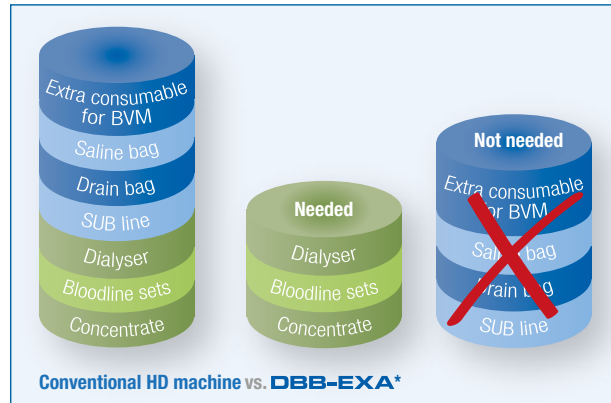

*When using DBB-EXA with D-FAS and BVM option.

Less waste

Drain of bloodline sets: This newly implemented feature can lead to significant cost-savings by reducing the weight of the contaminated waste.



Minimized maintenance costs

With **inherited reliability** and time-proven mechanical components of the DBB series, DBB-EXA can minimize maintenance costs with simple preventive maintenance and **long MTBF** (Mean Time Between Failure).



Smart design for patients & users

The patient is located in the immediate vicinity of the dialysis machine whilst on treatment.

DBB-EXA provides a **comfortable treatment environment** for the patient through its sleek and compact design.

The operator will appreciate well-thought-out features facilitating handling and daily routine.



Integrated document holder keeping patients area neat and tidy.



Grip handle with integrated cable hook for ease of maneuverability.



Blood pressure monitor cuff holder with **detachable flap** for ease of cleaning.

- The slim dimensions and the **ergonomic design** soften the mechanical aspect and make it easy to integrate DBB-EXA into a modern dialysis facility.
- The screen motion sensor enabling **automatic switch-off/on** of screen provides a more **comfortable** treatment environment for the patients.
- Integrated BVM, online port and drain port give the machine a **neat appearance**.
- The **contactless** patient card keeps the card reader surface clean ensuring **smooth data transfer**.

/ Connectivity for external alarming device

DBB-EXA is the first dialysis system complying with IEC PAS 63023 (Publicly Available Specification).

According to the signal from **an external alarming device** (e.g. a Venous Needle Dislodgement System) DBB-EXA triggers an alarm and **immediately switches** into a safe mode **to minimize risk to the patient**.

User-friendly interface

The user-friendly interface has **operational guidance** with intuitive graphical instructions. Using D-FAS and patient card, the number of screens and data entry is minimized to simplify the operation and reduce set-up time. Displayed information can be **customized individually** to fulfill all the dialysis facilities requirements.

The central image shows a dialysis machine with a large touch screen at the top. Callout boxes point to specific features: the screen, a preparation screen, a drain port, a brake pedal, and smooth curved surfaces for cleaning. A 'Clean coupling' callout points to a specific port on the machine.

Basic screen during a treatment. Monitors and keys are customizable.

15 inch flat touch screen with wide viewing angle. 4 colored status display on top of the screen **with 360° visibility**.

Preparation screen Intuitive guidance to set up blood-line set.

Smooth curved surfaces allowing for **easy cleaning**.

The **drain port** negates the need for a waste bag during priming.

Clean coupling®

Simple and easy **brake pedal**, enabling locking of all 4 wheels.

* for details, see p. 14

Automation



Dialysis Full Assist System

Supporting nursing staff

Healthcare professionals in the dialysis facility have many tasks to complete such as lining, priming, entering prescribed treatment data, blood filling and wash back besides the primary role of patient care.

Dialysis Full Assist System (D-FAS) can simplify and automate user operations.

As a result, it may be possible that operator errors and/or the risk of contamination can be significantly reduced.

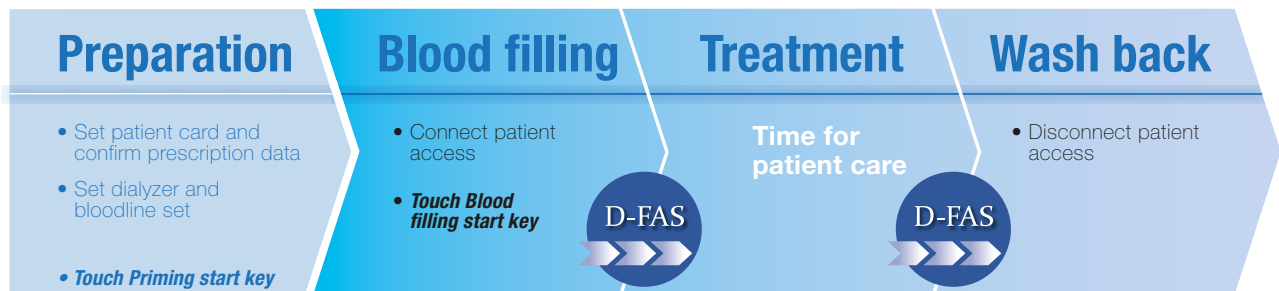

Bringing nursing staff back to patient care.

Advantages

- **Reducing** standard operational tasks between treatments such as preparation, connecting and disconnecting patients.
- **Minimizing** the number of times the operator has to interact with DBB-EXA.
- **Simplifying** and automating the tasks to reduce operator errors and risks of contamination.
- Dialysis facility can select automatic priming, wash back and emergency bolus utilizing **dialysis fluid or saline** (based on the facilities policy).
- Automatic wash back solution **can be switched** from dialysis fluid to saline. So the operator can keep the automatic wash back procedure even if the power supply is interrupted.
- D-FAS blood filling is **selectable** with or without UF.



D-FAS priming

The operator installs the bloodline set and dialyzer, and then starts **D-FAS priming**. D-FAS **automatically** primes the extracorporeal circuit without operator intervention.

D-FAS blood filling

With DBB-EXA, the venous and arterial patient access are connected **at the same time**.

The operator simply connects the arterial and venous patient access and starts **D-FAS blood filling**.

Depending on the **patient's condition**, it can be defined via the settings whether the patient should be connected **with or without UF**.

By selecting **D-FAS blood filling with UF**, the priming solution can automatically be removed through the dialyzer, therefore the **patients UF removal can be minimized**.



Guidance screen for set-up



D-FAS Connect & Blood filling screen



D-FAS Wash back & Disconnect screen

D-FAS emergency bolus

The operator can start the emergency bolus without handling the bloodline set. **D-FAS emergency bolus** can deliver automatically a defined volume of substitution fluid to the patient.

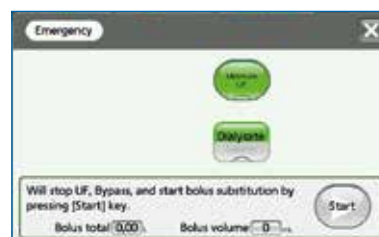

Emergency bolus programming screen

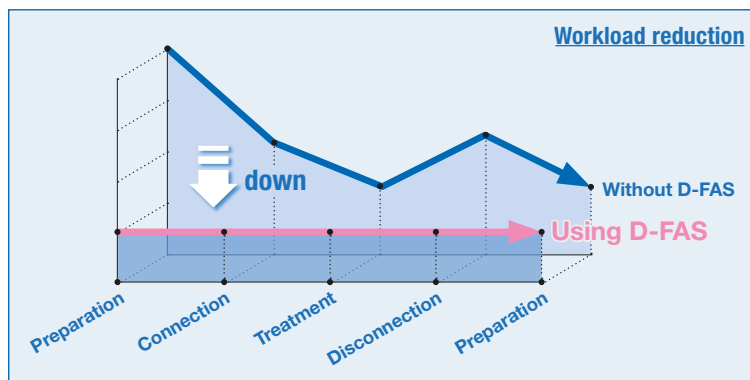

Graphical representation of the workload **with** and **without** D-FAS (example)

Automation

Bi-directional Patient Card – Stand-alone data management solution

EASY - FAST - FLEXIBLE (without network system)

The **prescription data** can be imported to the DBB-EXA via the personal patient card, easily and fast, and without any cable connection. The last 3 treatments are available on the **contactless** (RFID technology) patient card as a data package for export to the data management system.

Not requiring any data cable installation throughout the dialysis center, this **flexible** stand-alone solution from NIKKISO offers a simple and fully autonomous data management.



Data transfer with patient card

CONVENIENT - ACTUAL - FLEXIBLE (with network system)

By connecting the DBB-EXA to your network with Ethernet cables, **up-to-date information** about the current treatment parameters are available in your data management system. With the DBB-EXA patient card, and regardless of the used data management system and network connection, the import of the prescription data is fast and safe. Thanks to this newly achieved **autonomy** in bi-directional data transmission via patient card, potential network breakdown has no impact on the daily routine and you remain independent from any binding cooperation with a specific data management system supplier.

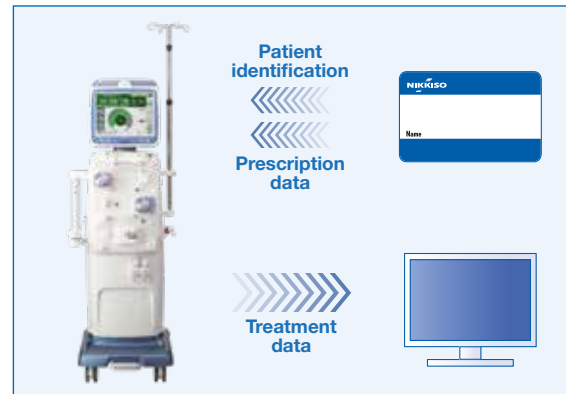

Data transfer with patient card and network system



Contactless patient card reader



Advantages of the Dialysis Dose Monitor

- Real-time monitoring
- Recognize treatment inconsistencies
- Easy handling
- No additional costs for disposables

Dialysis Dose Monitor

Positive long-term prognosis & higher quality of life for your patients

Several studies have proven that a positive long-term prognosis and improved quality of life (QOL) of patients **depends on the actual delivery of dialysis dose**. Adequate dialysis dose may improve QOL¹⁻³.

Insufficient clearance performance can have various reasons:

- No counter flow of blood and dialysis fluid due to incorrect connection
- Vascular access recirculation (the option **Vascular access recirculation rate measurement** can help monitor recirculation)
- Secondary membrane formation and/or dialyzer clotting
- Frequent alarms of dialysis machine which shorten effective treatment time
- Reduced effective blood flow etc.

Reaching treatment goals

Reaching the individual treatment goals for your patients **can only be achieved by always knowing the actual status**.

At the same time, necessary adaption of treatment parameters must be considered.

By using the Dialysis Dose Monitor, measured Kt/V is displayed in graphic form with a projection line. **You can see deviations from the treatment goal at an early stage, and react accordingly.**

The graph always shows the **Kt/V**.

Further, the values K, Kt, Kt/V and eKt/V can be **numerically** displayed by pressing this **key**.



Treatment-specific projection line

Measurement principle of the DDM

A sensor located directly in the spent dialysis fluid measures the absorbance at a wavelength which directly correlates with patient blood urea nitrogen (BUN) concentration. The continuously measured values are inserted in the formulas for single pool Kt/V (spKt/V) (based on Daugirdas) and for urea reduction ratio (URR). The results are **immediately** displayed.

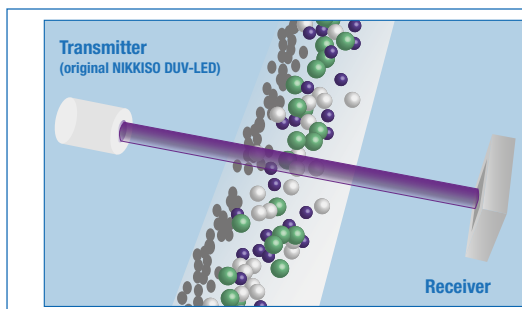

Measurement principle with DUV-LED

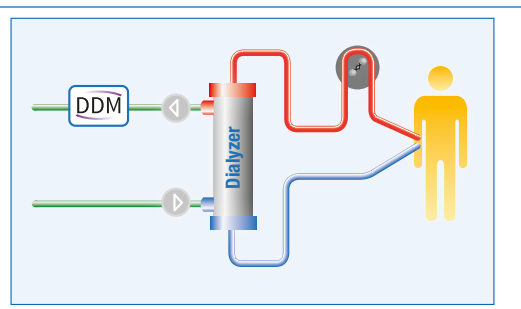

Location of the module directly in the drain system of the DBB-EXA

REFERENCES

1. Depner T, Daugirdas J, Greene T, et al. Dialysis dose and the effect of gender and body size on outcome in the HEMO study. *Kidney Int* 2004; 65: 1386-1394
2. Greene T, Daugirdas J, Depner T, et al. Association of Achieved Dialysis Dose with Mortality in the Hemodialysis Study: An Example of "Dose-Target Bias". *J Am Soc Nephrol* 2005; 16: 3371-3380
3. Port FK, Ashby VB, Dhingra RK, et al. Dialysis Dose and Body Mass Index Are Strongly Associated with Survival in Hemodialysis Patients. *J Am Soc Nephrol* 2002; 13: 1061-1066

Useful features

Monitoring patient blood pressure and blood volume

Common complications during hemodialysis are hypotension (20-30% of dialysis sessions), cramps (5-20%), nausea and vomiting (5-15%). Hypotension is related to the plasma volume that is removed during an average dialysis session. Cramps, nausea and vomiting are considered as associated with hypotension⁴. **Fluid management becomes a key clinical objective.**

Body water distribution in the human body

Total body water is distributed between the intracellular fluid (ICF) compartment (2/3) and the extracellular fluid (ECF) compartment (1/3). The ECF compartment is further subdivided into interstitial fluid (3/4 of ECF) and plasma (1/4 of ECF)⁵.

UF rate and Plasma refilling rate

Ultrafiltration during treatment is exclusively from blood plasma. Fluid volume reduction of blood initiates plasma refilling from other compartments to recover fluid volume. This refilling rate is called plasma refilling rate (PRR). If UF rate is equal to or less than PRR, blood volume is kept the same or recovered. If UF rate is greater than PRR, blood volume is reduced.

Inappropriate reduction in blood volume not fitting patient condition can result in a blood pressure drop⁶.

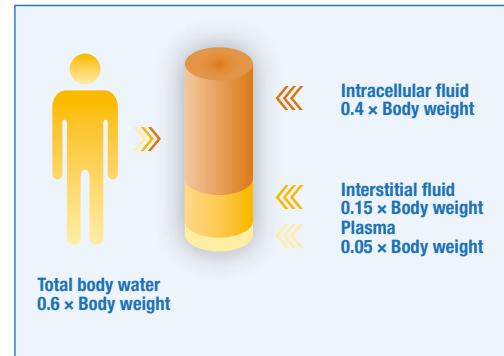

Distribution of fluids in human body

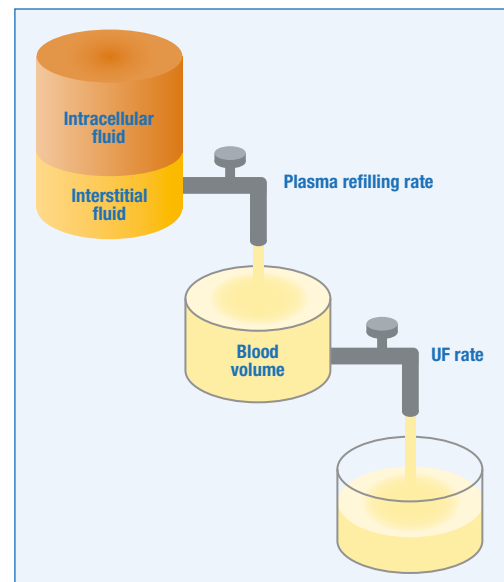

Fluid balance between different compartments

REFERENCES

4. Daugirdas JT, Ing TS. Handbook of Dialysis Second Edition. Little, Brown and Company, Boston, MA: 1994; 149-157
5. Koepfen BM, Stanton BA. Renal Physiology Fifth Edition. Mosby, Maryland Heights, MO: 2012; 1-14
6. Ronco C, Bellomo R, Ricci Z. Hemodynamic Response to Fluid Withdrawal in Overhydrated Patients Treated with Intermittent Ultrafiltration and Slow Continuous Ultrafiltration: Role of Blood Volume Monitoring. Cardiology 2001; 96: 196-201

Blood pressure monitors

DBB-EXA can measure the blood pressure with the integrated BPM. Measurement timing can be selected between manual, auto measurement or continuous.



/ Blood Pressure Monitor with linear inflation technology

iNIBP gradually increases cuff pressure whilst simultaneously measuring pulse oscillations during inflation. The cuff pressure is immediately released after systolic pressure is detected. Therefore, when compared to conventional deflationary method, **the iNIBP measurement time is shorter and target inflation pressure is lower, maximizing patient comfort.**⁷

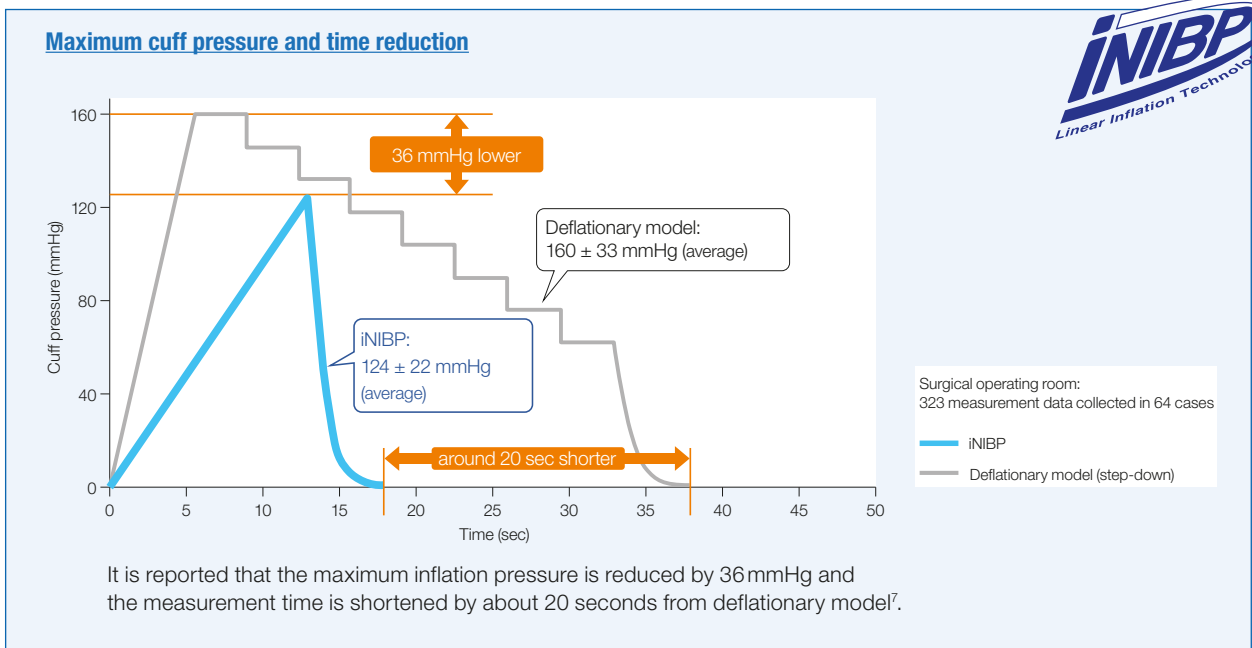

Comparison between Blood Pressure Monitor with linear inflation technology versus conventional deflationary (step-down) method



/ Blood Pressure Monitor with conventional depressurization method

The conventional blood pressure monitor quickly increases cuff pressure until the target pressure is reached and then gradually releases the pressure (deflationary/step-down method) until pulse waves are detected to measure the blood pressure.

Both Blood Pressure Monitors enable the results to be displayed in graphical form.
The blood pump speed and UF rate can be automatically reduced to customizable values if the SYS blood pressure alarm setting is reached.

REFERENCES

7. Onodera, J; Kotake, Y; Fukuda, M et al. Validation of inflationary non-invasive blood pressure monitoring in adult surgical patients. J Anesth. 2011, 25(1), 127-130.



Blood Volume Monitor (BVM) and Plasma Refilling Rate (PRR)

The BVM module transmits light near the infrared spectrum through the bloodline. This light with a specific wavelength is reflected by the red blood cells and the intensity of reflection is measured.

Patient blood volume and blood cell concentration in the arterial bloodline are correlated. Haemo-Master observes the change of reflected light during the treatment and a change of patient blood volume (dBV) can be monitored continuously.



BVM sensors

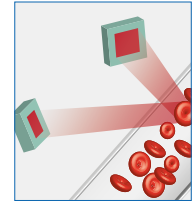

Measurement principle

Blood volume measurement is considered as a useful tool to help improve tolerance and the hemodynamic response¹⁰.

Estimated patient Plasma Refilling Rate (PRR) is calculated from UF rate and dBV trend. Nephrologists can refer to the PRR to help estimate adequate UF rate to stabilize the dBV. The monitored dBV and PRR are displayed in graphical form and clinicians can observe the patient fluid status visually.



Patient-specific progression curves showing relative blood volume change (dBV)

— Plasma Refilling Rate (PRR)
— UF rate (BV-UFC)
— Dialysis fluid conductivity (BV-COC)

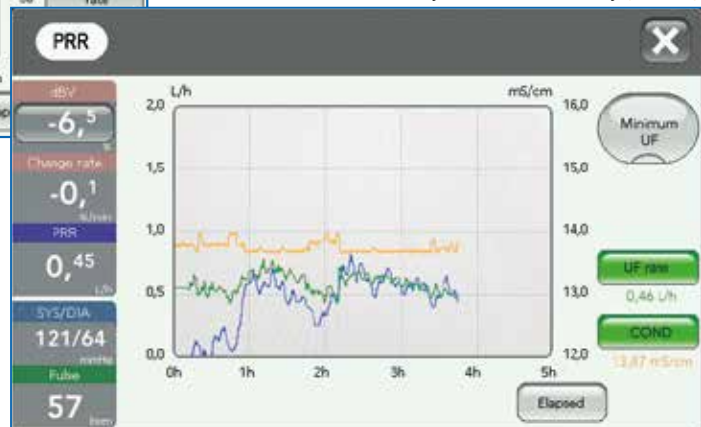

Patient-specific progression curves showing Plasma Refilling Rate (PRR), UF rate (BV-UFC) and dialysis fluid conductivity (BV-COC)

BV-UFC and BV-COC

A patient-specific ideal blood volume curve can be established.

DBB-EXA continuously measures dBV during the dialysis treatment. This is the basis for automatic regulation of the UF rate (BV-UFC) and dialysis fluid conductivity (BV-COC) so that patient dBV follows the ideal curve. Some studies show that automatic regulation of the UF rate and dialysis fluid conductivity reduces incidents of hypotensive episodes and the frequency of symptoms during the treatment⁸⁻¹⁰.

REFERENCES

- Carlo Basile, Rosa Giordano, Luigi Vernaglione, et al. Efficacy and safety of haemodialysis treatment with the Hemocontrol biofeedback system: a prospective medium-term study. *Nephrol Dial Transplant* 2001; 16: 328-334
- Santoro A, Mancini E, Paolini F, et al. Blood Volume Regulation During Hemodialysis. *Am J Kidney Dis* 1998; 32: 739-748
- Santoro A, Mancini E, Basile C, et al. Blood volume controlled hemodialysis in hypotension-prone patients: A randomized, multicenter controlled trial. *Kidney Int* 2002; 62: 1034-1045



Vascular access recirculation rate measurement*

The vascular access is the link between the patient and the extracorporeal blood circuit. Since the effectiveness of dialysis treatment depends, among other things, on the amount of purified blood, vascular access can be considered as the patient's lifeline, to which special attention should be paid.

Recirculation

Blood that has already been purified can return to the extracorporeal blood circuit without having previously saturated itself with metabolic end products. **This is called recirculation.**

Many factors (invisible for the operator) can influence recirculation in the vascular access. Abnormalities, such as reduced arterial blood flow or obstruction in venous side can result in extracorporeal blood flow being higher than the real vascular access blood flow.

However, there are other factors that can lead to recirculation, such as inadvertent swapping of the blood tubing connections, unfavorable needle positioning, or too short a distance between the needles, to name just a few.

The NIKKISO vascular access recirculation rate measurement option for detection and monitoring of recirculation is an outstanding tool to ensure a long-term assessment of vascular access.

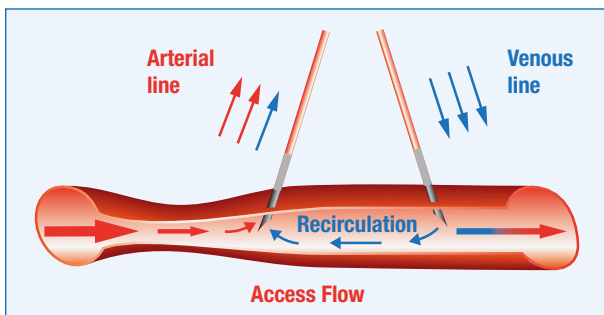

Example of recirculation caused by vascular access stenosis

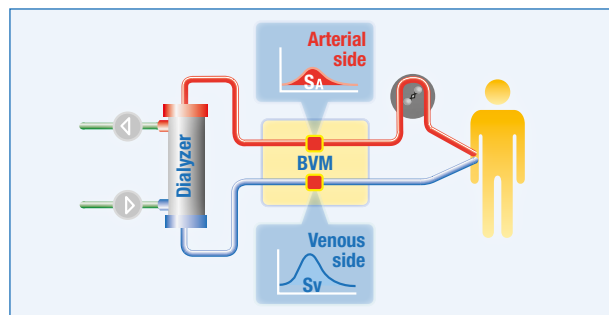

Recirculation rate – Measurement principle

Protecting vascular access

The newly developed **recirculation rate measurement system** is based on the Blood Volume Measurement (BVM) hardware that is used in the DBB-EXA. It is a double measuring system in the arterial and venous bloodline. If access recirculation exists, a blood marker produced by rapid ultrafiltration as a mass of concentrated blood in the extracorporeal venous line occurs in the arterial line. The rate of vascular access recirculation is calculated by the ratio of the integration of the arterial variation (Sa) to that of the venous (Sv) using the equation:

$$\text{Vascular access recirculation rate (\%)} = \text{Sa} / \text{Sv} \times 100$$

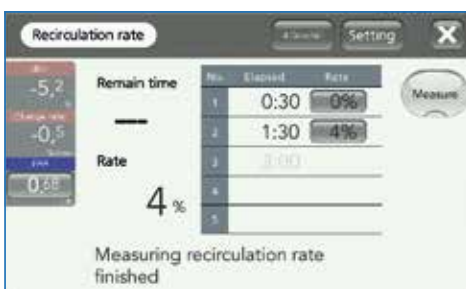

Recirculation rate – Schedule and results

Up to five automated measurements per treatment can be scheduled. Manual initiation of the measurement is also possible. The special measurement method allows recirculation measurement in the treatment modalities HD, HDF, HF and ISO-UF **without any blood dilution or infusion**. This also applies when using double-lumen catheters. The original NIKKISO AV18 series blood tubing lines are specially designed for BVM and the recirculation rate measurement.

* hereafter referred to as "recirculation rate"

Hygiene & Treatment optimization

Hygiene

Dialysis fluid and substitution fluid are both purified using the integrated reusable double filtration (cascade) with two EF-02 D endotoxin retentive filters (ETRF). Consequently, **the dialysis fluid is as purified as the substitution fluid**.

Dialyzer couplings and online port are designed and manufactured in such a way that during disinfection **all dialysis fluid contact areas are disinfected** to help avoid contamination.

By reducing the number of connections required for priming, recirculation, connection, bolus and wash back, DBB-EXA helps prevent the contamination of the patient access connection and **reduce the risk of vascular access infection**.

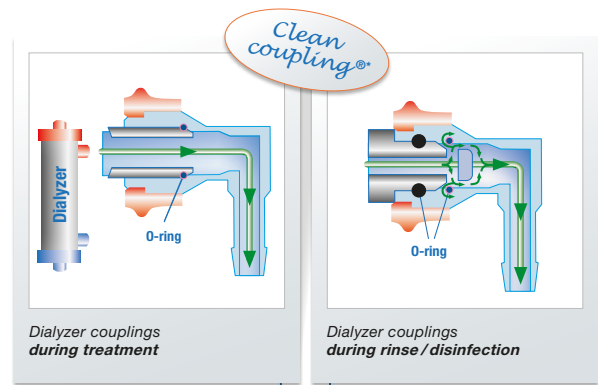

EF-02D easily accessible behind the front panel for a user-friendly replacement

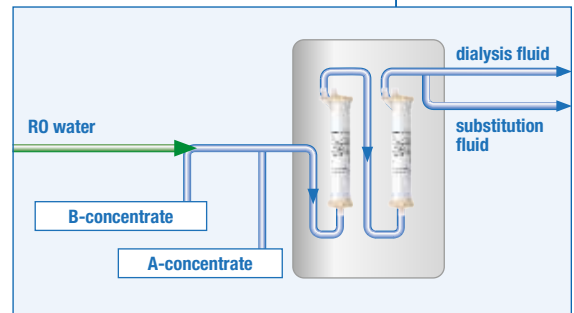

Hydraulic system with two endotoxin retentive filters EF-02D

Online HDF

Hemodiafiltration (HDF) has an **improved clearance of low molecular weight protein** compared with hemodialysis (HD), and is considered as a treatment mode with higher dialysis efficiency.

Recently several prospective studies which compare HDF with HD have been conducted in large scale¹¹⁻¹⁴. The ESHOL study reported that post-dilution Online HDF with high convection volume **reduces all-cause mortality**¹⁵.

DBB-EXA is a flexible dialysis machine which can perform different treatment methods such as post- or pre-dilution HDF, HF, HD and isolated UF.

DBB-EXA can optimize the substitution rate based on the set ratio with blood flow rate. Also substitution rate can be controlled automatically within set TMP limits. **This helps prevent high blood concentration and TMP alarms**.

TMP-SUB control



With the **TMP-SUB control** function, the TMP will be regulated within selected TMP limits **to achieve the highest possible filtration rate**.

Filtration Fraction



The **Filtration Fraction** function can optimize the convective volume **for improved therapy outcome**. The calculation of the optimal substitution volume is based on the patient's individual blood parameters.

Both TMP-SUB control and Filtration Fraction functions avoid excessive hemoconcentration and TMP alarms whilst optimizing substitution volume.

REFERENCES

11. Locatelli F, Altieri P, Andruzzi S, et al. Hemofiltration and hemodiafiltration reduce intradialytic hypotension in ESRD. *J Am Soc Nephrol* 2010; 21: 1798-1807
12. Ok E, Asci G, Ok ES, et al. Comparison of postdilution on-line hemodiafiltration and hemodialysis (Turkish HDF study). Abstract on EDTA-ERA (LBCT2) 2011
13. Penne EL, Blankestijn PJ, Bots ML, et al. Resolving controversies regarding hemodiafiltration versus hemodialysis : the Dutch Convective Transport Study. *Semin Dial* 2005; 18: 47-51
14. Grooteman M, van den Dorpel R, Bots M, et al. Online hemodiafiltration versus low-flux hemodialysis : effects on all-cause mortality and cardiovascular event in a randomized controlled trial. The convective transport study (CONTRAST). Abstract on EDTA-ERA (LBCT3) 2011
15. Maduell F, Mareso F, Pons M, et al. High-efficiency postdilution Online Hemodiafiltration Reduces All-Cause Mortality in Hemodialysis Patients. *J Am Soc Nephrol* 2013; 24: 487-497

Specifications*

General data

Dimensions	161 x 43 x 46 (H x W x D in cm) Base: 51 x 74 (W x D in cm)
Weight	Approx. 90 kg (incl. all options)
Water supply	Pressure: 1 to 7 bar at minimum 800 mL/min at maximum 3000 mL/min Temp.: 5 to 30 °C
Drain	Minimum drain capacity: 800 mL/min average Height: 50 cm maximum Temp.: 90 °C maximum
Concentrate supply	Pressure: 0 to 0,5 bar 2 central acid concentrates
Power supply	220 to 240 VAC ±10%, 50 to 60 Hz ±1 Hz (≈10A)
Battery	Ni-MH battery 24 V/3200 mAh
External connection port	External output (Staff call) External input 1 External input 2 Nurse call switch LAN/Network (RJ-45) Serial interface (RS-232) BPM start switch USB CF card type I
PAS	Input interface for external alarming device (IEC PAS 63023) to stop extracorporeal and/or fluid circuit
Monitor	15 inch LCD

Hydraulic circuit

Dialysis fluid flow rate	Setting range: Single ETRF 300 to 800 mL/min Double ETRF 300 to 700 mL/min
Dialysis fluid temperature	Setting range: 34.0 to 40.0 °C
Dialysis fluid conductivity	Bicarbonate dialysis Bicarbonate conductivity setting range: 2.3 to 7.0 mS/cm Accuracy: ±0.1 mS/cm Total conductivity setting range: 12.7 to 15.2 mS/cm Accuracy: ±0.2 mS/cm Acetate dialysis Total conductivity setting range: 12.7 to 15.2 mS/cm Accuracy: ±0.2 mS/cm
Transmembrane pressure (TMP)	Measurement range: -100 to +500 mmHg Measurement accuracy: ±10 mmHg
Blood leak detector	Method: Optical Sensitivity: 0.3 mL Blood/1 L Dialysis fluid (Blood: Hematocrit 32 ± 2%; Dialysis fluid temperature: 37 °C)
Ultrafiltration	UF rate: 0.00; 0.10 to 4.00 L/h UF accuracy (Balance): ±30 mL/h (At dialysis fluid flow rate 300 to 500 mL/min) ±0.1% of the dialysis fluid flow rate (At dialysis fluid flow rate 501 to 800 mL/min)
Dialysis Dose Monitor	Measurement principle: Absorptiometry Applicable Treatment mode: HD, On-line HDF Applicable Kt/V range: 0 to 3.0 Kt/V monitoring accuracy: ±0.1 (Kt/V 0 to 1) ±10% (Kt/V 1 to 3) Applicable URR range: 0% to 100% URR monitoring accuracy: ±5%
Endotoxin retentive filter (ETRF)	EF-02D

Treatment options

Online HDF/HF	Substitution flow setting range: 0.00; 0.10 to 18.00 L/h (Online HDF) 0.00; 0.10 to 30.00 L/h (Online HF) Flow rate accuracy: ±10% of set value
Single needle treatment	Single needle single pump treatment Single needle double pump treatment SN control pressure: Upper limit: +400 mmHg Lower limit: 0 mmHg
UF profiles	9 programmable profiles available
Conductivity profiles	9 programmable profiles available

Extracorporeal circuit

Arterial pressure monitoring	Measurement range: -300 to +500 mmHg Measurement accuracy: ±10 mmHg
Venous pressure monitoring	Measurement range: -300 to +500 mmHg Measurement accuracy: ±10 mmHg
Dialyser inlet blood pressure monitoring	Measurement range: -300 to +735 mmHg Measurement accuracy: ±10 mmHg
Single needle pressure	Measurement range: -200 to +600 mmHg Measurement accuracy: ±10 mmHg
Air detector	Method: Ultrasonic waves Sensitivity: 0.02 mL (normal air bubbles) (At Blood flow rate: 250 mL/min) 0.0003 mL (microbubbles: blood/air mixture) (At Blood flow rate: 250 mL/min)
Arterial blood pump (PUMP1)	Setting range: 40 to 600 mL/min Flow rate accuracy: Set value ±10% (inlet Pressure -150 mmHg ≤ P ≤ +150 mmHg) Set value -20 to 0% (inlet Pressure -200 mmHg ≤ P < -150 mmHg)
Heparin pump	Setting range: 0.0 to 9.9 mL/h Output rate accuracy: Set value ±10% Syringe type: 30 mL or 20 mL, 20 mL or 10 mL (optional) Bolus volume: 0.0 to 9.9 mL
Venous blood pump / Substitution fluid pump (PUMP2)	Setting range: 40 to 600 mL/min Flow rate accuracy: Set value ±10% (inlet Pressure -150 mmHg ≤ P ≤ +150 mmHg) Set value -20 to 0% (inlet Pressure -200 mmHg ≤ P < -150 mmHg)
Blood Pressure Monitor (BPM)	Pressure display range: 10 to 300 mmHg Pressure display accuracy: Less than ±3 mmHg Measurement range (adults): Systolic blood pressure (SYS): 60 to 250 mmHg Mean arterial pressure (MAP): 45 to 235 mmHg Diastolic blood pressure (DIA): 40 to 200 mmHg Pulse rate: 40 to 200 beats per minute <i>For iNIBP:</i> Pressure display range: 0 to 300 mmHg Pressure display accuracy: Less than ±3 mmHg Measurement range: Adult systolic blood pressure (SYS): 40 to 280 mmHg Mean arterial pressure (MAP): 10 to 280 mmHg Diastolic blood pressure (DIA): 10 to 235 mmHg Pulse rate: 30 to 200 beats per minute
Blood Volume Monitor (BVM)	Measurement principle : Near-infrared reflection method Applicable blood flow rate range: 40 to 600 mL/min Applicable hematocrit range: 15 to 50% Accuracy: ±2.3 dBV% (Double needle)
Vascular access recirculation rate measurement	Usable treatment modes: HD, ISO-UF, OHF, OHDF Measurement range: 0–100% Measurement accuracy: ±10 (recirculation ratio %) Measurement times: Maximum 5 times Usable blood flow rate range: 100–600 ml/min Usable hematocrit value range: BVM measurement range 15 to 50% Usable blood tubing lines: NIKKISO AV18-series

Accessories

Hook for concentrate bags	Max. load 10 kg
Patient card	MIFARE Classic 4K Capacity: 4096 bytes
Nurse call switch	

Cleaning program

Disinfection and decalcification	Heat disinfection with 50% Citric acid Chemical disinfection with DIALOX (Peracetic acid)
Disinfection and degreasing	Sodium hypochlorite solution (Maximum 10%)
Decalcification	30% Acetic acid

* Those specifications are valid for software version 1.6 or above and may differ depending on the DBB-EXA type (type A, B or C).



Inherited reliability

Contact us

Telephone +49 40 414629 - 0
info@nikkiso-europe.eu

Manufacturer
NIKKISO CO., LTD.

20-3, Ebisu 4-Chome, Shibuya-ku
Tokyo 150-6022, Japan
Telephone: +81-3-3443-3727
Fax: +81-3-3440-0681
Website: www.nikkiso.com

European Authorized Representative
NIKKISO Europe GmbH

Desbrocksriede 1
D-30855 Langenhagen
Telephone: +49 511 679999 - 0
Fax: +49 511 679999 - 11
E-Mail: info@nikkiso-europe.eu

Local partner

